

25HBB, 25HBC, 25HCD
Comfort™ Series Heat Pumps
with Puron® Refrigerant
1–1/2 To 5 Nominal Tons



Installation Instructions

NOTE: Read the entire instruction manual before starting the installation.

SAFETY CONSIDERATIONS

Improper installation, adjustment, alteration, service, maintenance, or use can cause explosion, fire, electrical shock, or other conditions which may cause death, personal injury, or property damage. Consult a qualified installer, service agency, or your distributor or branch for information or assistance. The qualified installer or agency must use factory–authorized kits or accessories when modifying this product. Refer to the individual instructions packaged with the kits or accessories when installing.

Follow all safety codes. Wear safety glasses, protective clothing, and work gloves. Use quenching cloth for brazing operations. Have fire extinguisher available. Read these instructions thoroughly and follow all warnings or cautions included in literature and attached to the unit. Consult local building codes and current editions of the National Electrical Code (NEC) NFPA 70. In Canada, refer to current editions of the Canadian electrical code CSA 22.1.

Recognize safety information. This is the safety–alert symbol . When you see this symbol on the unit and in instructions or manuals, be alert to the potential for personal injury.

Understand these signal words; DANGER, WARNING, and CAUTION. These words are used with the safety–alert symbol. DANGER identifies the most serious hazards which **will** result in severe personal injury or death. WARNING signifies hazards which **could** result in personal injury or death. CAUTION is used to identify unsafe practices which **may** result in minor personal injury or product and property damage. NOTE is used to highlight suggestions which **will** result in enhanced installation, reliability, or operation.



WARNING

ELECTRICAL SHOCK HAZARD

Failure to follow this warning could result in personal injury or death.

Before installing, modifying, or servicing system, main electrical disconnect switch must be in the OFF position. There may be more than 1 disconnect switch. Lock out and tag switch with a suitable warning label.



WARNING

EXPLOSION HAZARD

Failure to follow this warning could result in death, serious personal injury, and/or property damage.

Never use air or gases containing oxygen for leak testing or operating refrigerant compressors. Pressurized mixtures of air or gases containing oxygen can lead to an explosion.



INSTALLATION RECOMMENDATIONS

NOTE: In some cases noise in the living area has been traced to gas pulsations from improper installation of equipment.

1. Locate unit away from windows, patios, decks, etc. where unit operation sound may disturb customer.
2. Ensure that vapor and liquid tube diameters are appropriate for unit capacity.
3. Run refrigerant tubes as directly as possible by avoiding unnecessary turns and bends.
4. Leave some slack between structure and unit to absorb vibration.
5. When passing refrigerant tubes through the wall, seal opening with RTV or other pliable silicon–based caulk (see Fig. 1).
6. Avoid direct tubing contact with water pipes, duct work, floor joists, wall studs, floors, and walls.
7. Do not suspend refrigerant tubing from joists and studs with a rigid wire or strap which comes in direct contact with tubing (see Fig. 1).
8. Ensure that tubing insulation is pliable and completely surrounds vapor tube.
9. When necessary, use hanger straps which are 1 in. wide and conform to shape of tubing insulation (see Fig. 1).
10. Isolate hanger straps from insulation by using metal sleeves bent to conform to shape of insulation.

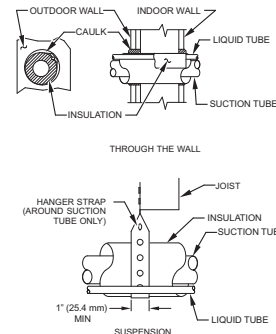

A07588

Fig. 1 - Connecting Tubing Installation

When outdoor unit is connected to factory–approved indoor unit, outdoor unit contains system refrigerant charge for operation with AHRI rated indoor unit when connected by 15 ft. (4.57 m) of field–supplied or factory accessory tubing. For proper unit operation, check refrigerant charge using charging information located on control box cover and/or in the Check Charge section of this instruction.

IMPORTANT: Maximum liquid–line size is 3/8–in. OD for all residential applications including long line.

IMPORTANT: Always install the factory–supplied liquid–line filter drier. Obtain replacement filter driers from your distributor or branch.

INSTALLATION

CAUTION

CUT HAZARD

Failure to follow this caution may result in personal injury. Sheet metal parts may have sharp edges or burrs. Use care and wear appropriate protective clothing and gloves when handling parts.

Check Equipment and Job Site

Unpack Unit

Move to final location. Remove carton taking care not to damage unit.

Inspect Equipment

File claim with shipping company prior to installation if shipment is damaged or incomplete. Locate unit rating plate on unit corner panel. It contains information needed to properly install unit. Check rating plate to be sure unit matches job specifications.

Install on a Solid, Level Mounting Pad

If conditions or local codes require the unit be attached to pad, tie down bolts should be used and fastened through knockouts provided in unit base pan. Refer to unit mounting pattern in Fig. 2 to determine base pan size and knockout hole location.

For hurricane tie downs, contact distributor for details and PE Certification (Professional Engineer), if required.

On rooftop applications, mount on level platform or frame. Place unit above a load-bearing wall and isolate unit and tubing set from structure. Arrange supporting members to adequately support unit and minimize transmission of vibration to building. Consult local codes governing rooftop applications.

Roof mounted units exposed to winds above 5 mph may require wind baffles. Consult the Service Manual – Residential Split System Air Conditioners and Heat Pumps for wind baffle construction.

NOTE: Unit must be level to within $\pm 2^\circ$ ($\pm 3/8$ in/ft, ± 9.5 mm/m) per compressor manufacturer specifications.

Clearance Requirements

When installing, allow sufficient space for airflow clearance, wiring, refrigerant piping, and service. Allow 24 in. (609.6 mm) clearance to service end of unit and 48 in. (1219.2 mm) (above unit. For proper airflow, a 6-in. (152.4 mm) clearance on 1 side of unit and 12-in. (304.8 mm) on all remaining sides must be maintained. Maintain a distance of 24 in. (609.6 mm) between units or 18 in. (457.2 mm) if no overhang within 12 ft. (3.66 m). Position so water, snow, or ice from roof or eaves cannot fall directly on unit.

NOTE: 18" (457.2 mm) clearance option described above is approved for outdoor units with wire grille coil guard only. Units with louver panels require 24" (609.6 mm) between units.

On rooftop applications, locate unit at least 6 in. above roof surface.

3/8-in. (9.53 mm) Dia.
Tiedown Knockouts in
Basepan(2) Places

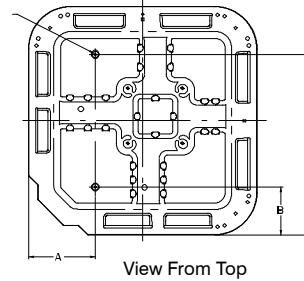

UNIT BASE PAN Dimension in. (mm)	TIEDOWN KNOCKOUT LOCATIONS in. (mm)		
	A	B	C
23 X 23 (585 X 585)	7-3/4 (196.8)	4-13/32 (111.9)	18-1/32 (457.9)
26 X 26 (660 X 660)	9-1/8 (231.8)	4-7/16 (112.7)	21-1/4 (539.8)
31-1/2 X 31-1/2 (800 X 800)	9-1/8 (231.8)	6-9/16 (166.7)	24-11/16 (627.1)
35 X 35 (889 X 889)	9-1/8 (231.8)	6-9/16 (166.7)	28-7/16 (722.3)

A05177

Fig. 2 - Tiedown Knockout Locations

Operating Ambient

The minimum outdoor operating ambient in cooling mode without accessory is 55°F (12.78°C), and the maximum outdoor operating ambient in cooling mode is 125°F (51.67°C). The maximum outdoor operating ambient in heating mode is 66 °F (18.89°C).

Check Defrost Thermostat

Check defrost thermostat to ensure it is properly located and securely attached. There is a liquid header with a distributor and feeder tube going into outdoor coil. At the end of the one of the feeder tubes, there is a 3/8 in. O.D. stub tube approximately 2 in. (50.8 mm) long (see Fig. 3). The defrost thermostat should be located on stub tube. Note that there is only one stub tube used with liquid header, and on most units it is the bottom circuit.

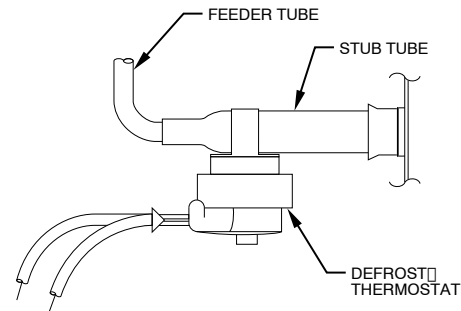

Fig. 3 - Defrost Thermostat Location

A97517

Table 1 – Accessory Usage

Accessory	REQUIRED FOR LOW-AMBIENT COOLING APPLICATIONS (Below 55°F / 12.8°C)	REQUIRED FOR LONG LINE APPLICATIONS*	REQUIRED FOR SEA COAST APPLICATIONS (Within 2 miles / 3.22 km)
Accumulator	Standard	Standard	Standard
Ball Bearing Fan Motor	Yes†	No	No
Compressor Start Assist Capacitor and Relay	Yes	Yes	No
Crankcase Heater	Yes	Yes	No
Evaporator Freeze Thermostat	Yes	No	No
Hard Shutoff TXV	Yes	Yes	Yes
Isolation Relay	Yes	No	No
Liquid Line Solenoid Valve	No	See Long-Line Application Guideline	No
Motor Master® Control or Low Ambient Switch	Yes	No	No
Support Feet	Recommended	No	Recommended

* For tubing line sets between 80 and 200 ft. (24.38 and 60.96 m) and/or 20 ft. (6.09 m) vertical differential, refer to Residential Piping and Longline Guideline. .
 † Additional requirement for Low-Ambient Controller (full modulation feature) MotorMaster® Control.

Always Ask For
FACTORY AUTHORIZED PARTS

Make Piping Connections

⚠ WARNING

PERSONAL INJURY AND ENVIRONMENTAL HAZARD

Failure to follow this warning could result in personal injury or death.

Relieve pressure and recover all refrigerant before system repair or final unit disposal.

Use all service ports and open all flow-control devices, including solenoid valves.

⚠ CAUTION

UNIT DAMAGE HAZARD

Failure to follow this caution may result in equipment damage or improper operation.

If ANY refrigerant tubing is buried, provide a 6-in (152.4 mm) vertical rise at service valve. Refrigerant tubing lengths up to 36-in (914.4 mm) may be buried without further special consideration. Do not bury lines longer than 36 in (914.4 mm).

Outdoor units may be connected to indoor section using accessory tubing package or field-supplied refrigerant grade tubing of correct size and condition. For tubing requirements beyond 80 ft, substantial capacity and performance losses can occur. Following the recommendations in the *Residential Piping and Long Line Guideline* will reduce these losses. Refer to Table 1 for accessory requirements. Refer to Table 2 for field tubing diameters.

There are no buried-line applications greater than 36 in. (914.4 mm)

If refrigerant tubes or indoor coil are exposed to atmosphere, they must be evacuated to 500 microns to eliminate contamination and moisture in the system.

Outdoor Unit Connected To Factory Approved Indoor Unit

Outdoor unit contains approximate system refrigerant charge for operation with approved AHRI rated indoor unit when connected by 15 ft (4.57 m) of field-supplied or factory-accessory tubing, and factory supplied filter drier. Some indoor units require additional subcooling to achieve optimal heating performance. Using Table 5 or 6- Additional Subcooling Required, check refrigerant charge for maximum efficiency

Refrigerant Tubing and Sweat Connections

Connect vapor tube to fitting on outdoor unit vapor service valves (see Table 2). Connect liquid tubing to adapter tube on liquid service valve. Use refrigerant grade tubing.

⚠ CAUTION

UNIT DAMAGE HAZARD

Failure to follow this caution may result in equipment damage or improper operation.

Service valves must be wrapped in a heat-sinking material such as a wet cloth while brazing.

Remove plastic retainer holding outdoor piston in liquid service valve, leaving the piston and piston retainer inside the valve. Connect sweat/flare adapter provided, to valve. (See Fig. 4.) Connect refrigerant tubing to fittings on outdoor unit vapor and liquid service valves. Service valves are closed from factory and ready for brazing. After wrapping service valve with a wet cloth, tubing set can be brazed to service valve using either silver bearing or non-silver bearing brazing material. Do not use soft solder (materials which melt below 800°F/427°C). Consult local code requirements. Refrigerant tubing and indoor coil are now ready for leak testing. This check should include all field and factory joints.

NOTE: Some outdoor units contain a mechanical fitting at the liquid distributor. This connection is not field serviceable and should not be disturbed.

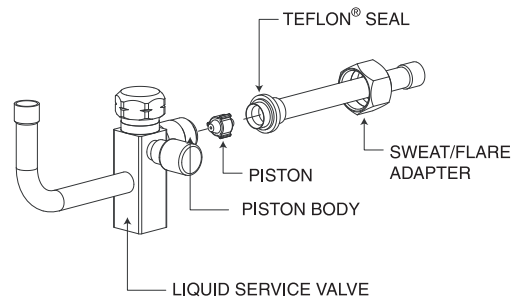

Fig. 4 - Liquid Service Valve

A05226

25HBB / 25HBC / 25HCD

Table 2 – Refrigerant Connections and Recommended Liquid and Vapor Tube Diameters (In.)

UNIT SIZE	LIQUID		RATED VAPOR	
	Connection Diameter	Tube Diameter	Connection Diameter	Tube Diameter
18, 24	3/8	3/8	5/8	5/8
30, 36	3/8	3/8	3/4	3/4
42, 48	3/8	3/8	7/8	7/8
60	3/8	3/8	7/8	1-1/8

* Units are rated with 25 ft. (7.6 m) of lineset. See Product Data sheet for performance data when using different size and length linesets.

Notes:

1. Do not apply capillary tube indoor coils to these units.
2. For Tubing Set lengths between 80 and 200 ft. (24.38 and 60.96 m) horizontal or 20 ft. (6.09 m) vertical differential 250 ft. (76.2 m) Total Equivalent Length, refer to the Residential Piping and Longline Guideline – Air Conditioners and Heat Pumps using Puron refrigerant.

Installing with Indoor Piston

Outdoor Unit Connected to Factory Approved Indoor Unit

Check piston size shipped with indoor unit to see if it matches required indoor piston size. If it does not match, replace indoor piston with correct piston size.

NOTE: Correct pistons are shipped with outdoor units in the accessory bag and are only qualified for piston fan coils. Example fan coils with piston: FB4C and FY5B (1.5 through 4 ton)

When changing indoor piston, use a back-up wrench. Hand tighten hex nut, then tighten with wrench 1/2 turn. Do not exceed 30 ft-lbs. The indoor piston contains a Teflon ring (or seal) which is used to seat against the inside of distributor body, and must be installed properly to ensure proper seating. See Fig. 5.

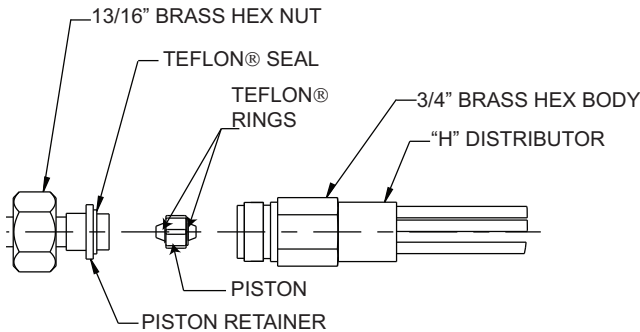

Fig. 5 - Indoor Piston Installation

A10342

Install Liquid Line Filter Drier Indoor

Refer to Fig. 6 and install filter drier as follows:

1. Braze 5 in. (127 mm) liquid tube to the indoor coil.
2. Wrap filter drier with damp cloth.
3. Braze filter drier to 5 in. (127 mm) long liquid tube from step 1.
4. Connect and braze liquid refrigerant tube to the filter drier.

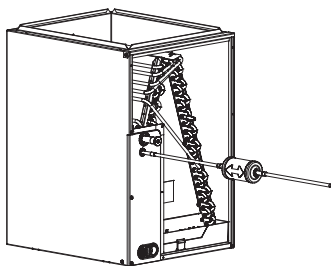

Fig. 6 - Liquid Line Filter Drier

A05227

CAUTION

UNIT DAMAGE HAZARD

Failure to follow this caution may result in equipment damage or improper operation.
Installation of filter drier in liquid line is required.

Evacuate Refrigerant Tubing and Indoor Coil

CAUTION

UNIT DAMAGE HAZARD

Failure to follow this caution may result in equipment damage or improper operation.
Never use the system compressor as a vacuum pump.

Refrigerant tubes and indoor coil should be evacuated using the recommended deep vacuum method of 500 microns. The alternate triple evacuation method may be used (see triple evacuation procedure in service manual). Always break a vacuum with dry nitrogen.

Deep Vacuum Method

The deep vacuum method requires a vacuum pump capable of pulling a vacuum of 500 microns and a vacuum gage capable of accurately measuring this vacuum depth. The deep vacuum method is the most positive way of assuring a system is free of air and liquid water. A tight dry system will hold a vacuum of 1000 microns after approximately 7 minutes. (See Fig. 7.)

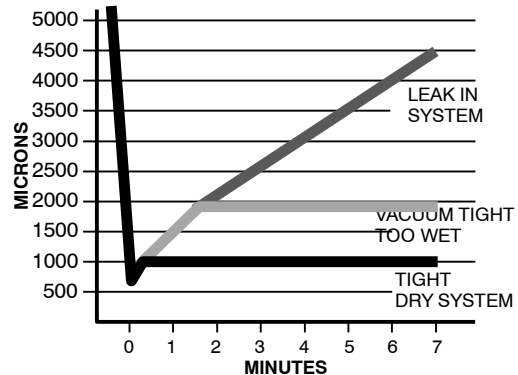

Fig. 7 - Deep Vacuum Graph

A95424

Final Tubing Check

IMPORTANT: Check to be certain factory tubing on both indoor and outdoor unit has not shifted during shipment. Ensure tubes are not rubbing against each other or any sheet metal. Pay close attention to feeder tubes, making sure wire ties on feeder tubes are secure and tight.

Be sure field wiring complies with local and national fire, safety, and electrical codes, and voltage to system is within limits shown on unit rating plate. Contact local power company for correction of improper voltage. See unit rating plate for recommended circuit protection device.

NOTE: Operation of unit on improper line voltage constitutes abuse and could affect unit reliability. See unit rating plate. Do not install unit in system where voltage may fluctuate above or below permissible limits.

Make Electrical Connections

⚠ WARNING

ELECTRICAL SHOCK HAZARD

Failure to follow this warning could result in personal injury or death.

Do not supply power to unit with compressor terminal box cover removed.

NOTE: Use copper wire only between disconnect switch and unit.

NOTE: Install branch circuit disconnect of adequate size per NEC to handle unit starting current. Locate disconnect within sight from and readily accessible from unit, per Section 440-14 of NEC.

Route Ground and Power Wires

Remove access panel to gain access to unit wiring. Extend wires from disconnect through power wiring hole provided and into unit control box.

Connect Ground and Power Wires

⚠ WARNING

ELECTRICAL SHOCK HAZARD

Failure to follow this warning could result in personal injury or death.

The unit cabinet must have an uninterrupted or unbroken ground to minimize personal injury if an electrical fault should occur. The ground may consist of electrical wire or metal conduit when installed in accordance with existing electrical codes.

Connect ground wire to ground connection in control box for safety. Connect power wiring to contactor as shown in Fig. 8.

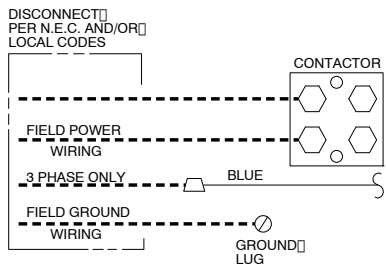
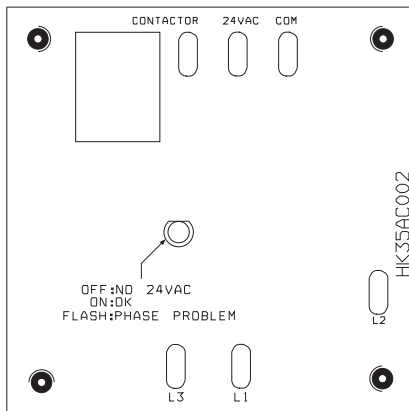

Fig. 8 - Line Connections

A94025



**Fig. 9 - 3-Phase Monitor Control
(Applies to 3-Phase Units Only)**

A00010

Table 3 – 3-Phase Monitor LED Indicators

LED	STATUS
OFF	No call for compressor operation
FLASHING	Reversed phase
ON	Normal

Connect Control Wiring

Route 24v control wires through control wiring grommet and connect leads to control wiring. See Thermostat Installation Instructions for wiring specific unit combinations. (See Fig. 10.)

Use No. 18 AWG color-coded, insulated (35°C minimum) wire. If thermostat is located more than 100 ft (30.5 m) from unit, as measured along the control voltage wires, use No. 16 AWG color-coded wire to avoid excessive voltage drop.

All wiring must be NEC Class 1 and must be separated from incoming power leads.

Use furnace transformer, fan coil transformer, or accessory transformer for control power, 24v/40va minimum.

NOTE: Use of available 24v accessories may exceed the minimum 40va power requirement. Determine total transformer loading and increase the transformer capacity or split the load with an accessory transformer as required.

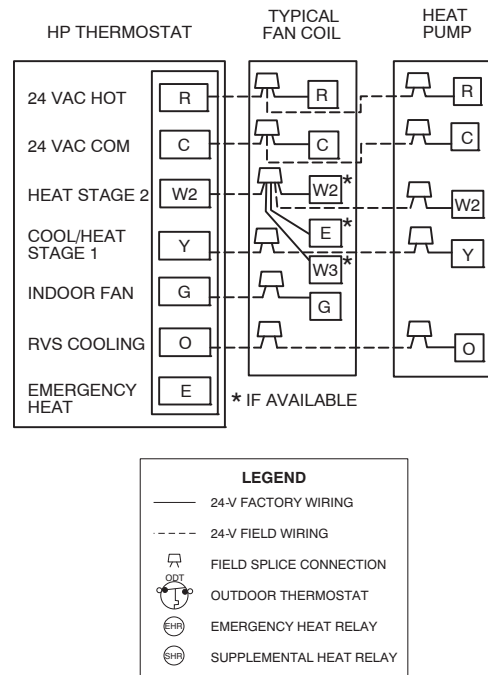

**Fig. 10 - Generic Wiring Diagrams
(See thermostat Installation Instructions
for specific unit combinations)**

A02325 / A97413

25HBB / 25HBC / 25HCD

Final Wiring Check

IMPORTANT: Check factory wiring and field wire connections to ensure terminations are secured properly. Check wire routing to ensure wires are not in contact with tubing, sheet metal, etc.

Compressor Crankcase Heater

When equipped with a crankcase heater, furnish power to heater a minimum of 24 hr before starting unit. To furnish power to heater only, set thermostat to OFF and close electrical disconnect to outdoor unit.

A crankcase heater is required if refrigerant tubing is longer than 80 ft (23.4 m), or when outdoor unit is 20 ft (6.09 m) below indoor unit. Refer to the Residential Piping and Long Line Guideline.

Install Electrical Accessories

Refer to the individual instructions packaged with kits or accessories when installing.

Start-Up



CAUTION

PERSONAL INJURY HAZARD

Failure to follow this caution may result in personal injury.

Wear safety glasses, protective clothing, and gloves when handling refrigerant and observe the following:

- Front seating service valves are equipped with Schrader valves.



CAUTION

ENVIRONMENTAL HAZARD

Failure to follow this caution may result in environmental damage.

Federal regulations require that you do not vent refrigerant to the atmosphere. Recover during system repair or final unit disposal.



CAUTION

UNIT OPERATION AND SAFETY HAZARD

Failure to follow this caution may result in personal injury, equipment damage or improper operation.

- Do not overcharge system with refrigerant.
- Do not operate unit in a vacuum or at negative pressure.
- Do not disable low pressure switch in scroll compressor applications.
- Compressor dome temperatures may be hot.

Follow these steps to properly start up system:

1. After system is evacuated, fully open liquid and vapor service valves.
2. Unit is shipped with valve stem(s) front seated (closed) and caps installed. Replace stem caps after system is opened to refrigerant flow (back seated). Replace caps finger-tight and tighten with wrench an additional 1/12 turn.
3. Close electrical disconnects to energize system.
4. Set room thermostat at desired temperature. Be sure set point is below indoor ambient temperature.
5. Set room thermostat to HEAT or COOL and fan control to ON or AUTO mode, as desired. Operate unit for 15 minutes. Check system refrigerant charge.

Sequence of Operation

Turn on power to indoor and outdoor units. Transformer is energized.

Cooling

On a call for cooling, thermostat makes circuits R-O and R-Y, and R-G. Circuit R-O energizes reversing valve, switching it to cooling position. Circuit R-Y energizes contactor, starting outdoor fan motor and compressor circuit. R-G energizes indoor unit blower relay, starting indoor blower motor on high speed.

When thermostat is satisfied, its contacts open, de-energizing contactor and blower relay. Compressor and motors should stop.

NOTE: If indoor unit is equipped with a time-delay relay circuit, the indoor blower will run an additional 90 seconds to increase system efficiency.

Heating

On a call for heating, thermostat makes circuits R-Y and R-G. Circuit R-Y energizes contactor, starting outdoor fan motor and compressor. Circuit R-G energizes indoor blower relay, starting blower motor on high speed.

Should temperature continue to fall, R-W2 is made through second-stage room thermostat. Circuit R-W2 energizes a relay, bringing on first bank of supplemental electric heat and providing electrical potential to second heater relay (if used). If outdoor temperature falls below setting of outdoor thermostat (field installed option), contacts close to complete circuit and bring on second bank of supplemental electric heat.

When thermostat is satisfied, its contacts open, de-energizing contactor and relay. All heaters and motors should stop.

Defrost

The defrost control is a time/temperature control which includes a field selectable (quick-connects located at board edge) time period between defrost cycles (30, 60, or 90 minutes), factory set to either 60 or 90 minutes.

The electronic defrost timer sequence is enabled when the T1 input on the board is energized. The timer starts only when the defrost thermostat is closed and the contactor is energized.

Defrost mode is identical to cooling mode except that outdoor fan motor stops and second-stage heat is turned on to continue warming conditioned spaces.

To initiate defrost, the defrost thermostat must be closed. This can be accomplished as follows:

1. Turn off power to outdoor unit.
2. Disconnect outdoor fan motor lead from OF2 on control board (see Fig. 11). Tape lead to prevent grounding.
3. Restart unit in heating mode, allowing frost to accumulate on outdoor coil.
4. After a few minutes in heating mode, liquid line temperature should drop below closing point of defrost thermostat (approximately 30°F/-1.11°C).
5. Short between speedup terminals with a flat-blade screwdriver. This reduces the timing sequence to 1/25th of original time. (See Table 4.)
6. When you hear reversing valve change position, remove screwdriver immediately; otherwise, control will terminate normal 10-minute defrost cycle in approximately 2 seconds.

NOTE: Length of defrost cycle is dependent upon length of time it takes to remove screwdriver from test pins after reversing valve has shifted.

7. Unit will remain in defrost for remainder of defrost cycle time or until defrost thermostat reopens at approximately 65°F (18.33°C) coil temperature of liquid line.
8. Turn off power to outdoor unit and reconnect fan motor lead to OF2 on control board.

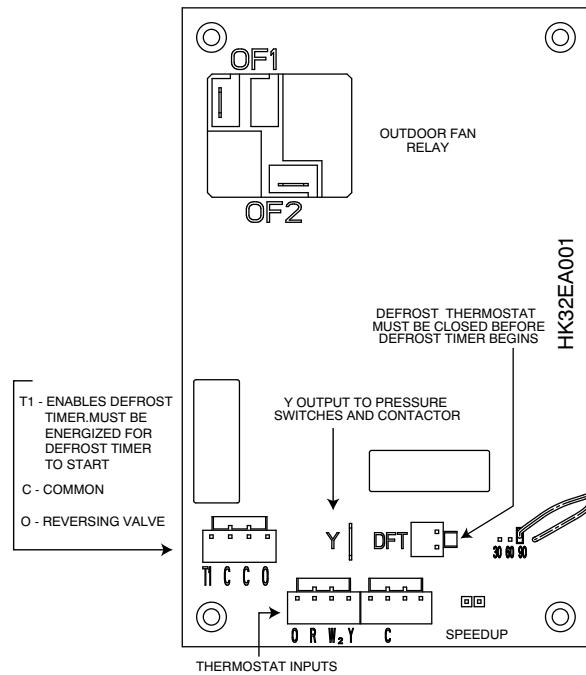

Fig. 11 - Defrost Control

A05332

Table 4 – Defrost Control Speedup–Timing Sequence

PARAMETER	MINIMUM (MINUTES)	MAXIMUM (MINUTES)	SPEEDUP (NOMINAL)
30-minute cycle	27	33	7 sec
50-minute cycle	45	55	12 sec
90-minute cycle	81	99	21 sec
10-minute cycle	9	11	2 sec
5 minutes	4.5	5.5	1 sec

Check Charge

Factory charge amount and desired subcooling are shown on unit rating plate. Additional subcooling may be required to achieve optimal heating performance based on the installed indoor unit. (see Table 5 or 6).

Charging method is shown on information plate inside unit. For TXV, use subcooling method. For piston, use superheat method. To properly check or adjust charge, conditions must be favorable for subcooling or superheat charging. Favorable conditions exist when the outdoor temperature is between 70°F and 100°F (21.11°C and 37.78°C), and the indoor temperature is between 70°F and 80°F (21.11°C and 26.67°C). Follow the procedure below:

Unit is factory charged for 15ft (4.57 m) of lineset. Adjust charge by adding or removing 0.6 oz/ft (.018 kg/m) of 3/8 liquid line above or below 15ft (4.57 m) respectively.

For standard refrigerant line lengths (80 ft/24.38 m or less), allow system to operate in cooling mode at least 15 minutes. If conditions are favorable, check system charge by super heat method for fixed metering device and subcooling method for TXV. If any adjustment is necessary, adjust charge slowly and allow system to operate for 15 minutes to stabilize before declaring a properly charged system. Refer to Table 5 or 6 for additional subcooling required.

If the indoor temperature is above 80°F (26.67°C), and the outdoor temperature is in the favorable range, adjust system charge by weight based on line length and allow the indoor temperature to drop to 80°F (26.67°C) before attempting to check system charge by subcooling method as described above.

If the indoor temperature is below 70°F (21.11°C), or the outdoor temperature is not in the favorable range, adjust charge for line set length above or below 15ft (4.57 m) only. Charge level should then be appropriate for the system to achieve rated capacity. The charge level could then be checked at another time when the both indoor and outdoor temperatures are in a more favorable range.

NOTE: If line length is beyond 80 ft (24.38 m) or greater than 20 ft (6.10 m) vertical separation, See Residential Piping and Long Line Guideline for special charging requirements.

Units with Cooling Mode TXV

Units installed with cooling mode TXV require charging by the subcooling method.

1. Operate unit a minimum of 10 minutes before checking charge.
2. Measure liquid service valve pressure by attaching an accurate gage to service port.
3. Measure liquid line temperature by attaching an accurate thermistor type or electronic thermometer to liquid line near outdoor coil.
4. Refer to unit rating plate for required subcooling temperature.
5. Refer to Table 7. Find the point where required subcooling temperature intersects measured liquid service valve pressure.
6. To obtain required subcooling temperature at a specific liquid line pressure, add refrigerant if liquid line temperature is higher than indicated or reclaim refrigerant if temperature is lower. Allow a tolerance of $\pm 3^\circ\text{F}$.

Units with Indoor Pistons

Units installed with indoor pistons require charging by the superheat method.

The following procedure is valid when indoor airflow is within ± 21 percent of its rated CFM.

1. Operate unit a minimum of 10 minutes before checking charge.
2. Measure suction pressure by attaching an accurate gage to suction valve service port.
3. Measure suction temperature by attaching an accurate thermistor type or electronic thermometer to suction line at service valve.
4. Measure outdoor air dry-bulb temperature with thermometer.
5. Measure indoor air (entering indoor coil) wet-bulb temperature with a sling psychrometer.
6. Refer to Table 8. Find outdoor temperature and evaporator entering air wet-bulb temperature. At this intersection, note superheat. Where a dash (—) appears on the table, do not attempt to charge system under these conditions or refrigerant slugging may occur. Charge must be weighted in, adding or removing 0.6 oz/ft of 3/8 liquid line above or below 15 ft (4.57 m) respectively.
7. Refer to Table 9. Find superheat temperature located in item 6 and suction pressure. At this intersection, note suction line temperature.
8. If unit has a higher suction line temperature than charted temperature, add refrigerant until charted temperature is reached.
9. If unit has a lower suction line temperature than charted temperature, reclaim refrigerant until charted temperature is reached.
10. When adding refrigerant, charge in liquid form into suction service port using a flow-restricting device.
11. If outdoor air temperature or pressure at suction valve changes, charge to new suction line temperature indicated on chart.

12. Optimum performance will be achieved when the operating charge produces 5° to 6°F suction superheat at suction service valve with 82°F outdoor ambient and 80°F (26.7°C) dry bulb (67°F / 19.4°C) wet bulb indoor temperature (DOE “B” test conditions) at rated airflow.

Heating Check Chart Procedure

To check system operation during heating cycle, refer to the Heating Check Chart on outdoor unit. This chart indicates whether a correct relationship exists between system operating pressure and air temperature entering indoor and outdoor units. If pressure and temperature do not match on chart, system refrigerant charge may not be correct. Do not use chart to adjust refrigerant charge.

Table 5 – Additional Subcooling Required – 13 & 14 SEER Units

Indoor Unit	Subcooling Delta from Rating Plate Value						
	Outdoor Unit Tonnage						
	018	024	030	036	042	048	060
CAP**1814A**	—						
CNPV*1814A**	—						
FB4CNF018+TXV	—						
FF1ENP(018/019)	—						
FX4DNF019	+3						
CAP**24**A**	+3	+3					
CNP**24**A**	+3	+3					
CSPH*2412A**	+5	+5					
FB4CNF024+TXV	—	—					
FF1ENP(024/025)	+5	+3					
(FV4C/FE4A)NF002	+5	+3	+3				
FX4DNF025	+5	+3					
CAP**30**A**		+3	—				
CNP**30**A**		+3	+3				
CSPH*3012A**		+3	+3				
FB4CNF030+TXV		+3	—				
FF1ENP030		+3	—				
FF1ENP031		+3	—				
FX4DN(B,F)031		+5	+5				
CAP**36**A**			+5	+3			
CNP**36**A**			+3	—			
CSPH*3612A**			+5	+3			
FB4CNF036+TXV			—	—			
(FV4C/FE4A)N(B,F)003		+5	+5	+3	—		
FF1ENP036			+5	+3			
FF1ENP037			+5	+3			
FX4DN(B,F)037			+5	+5			
CAP**42**A**				+3	—		
CNP**4221A**				+3	—		
CNPV*4217A**				+3	—		
CSPH*4212A**				+5	—		
FB4CNF042+TXV				+5	—		
FX4DN(B,F)043				+5	—		
CAP**4817A**					+5	+3	
CAP**48(21,24)A**					+3	—	
CNP**48**A**					—	—	
CSPH*4812A**					+3	—	
FB4CNF048+TXV					—	—	
(FV4C/FE4A)N(B,F)005			+5	+5	+3	—	—
FX4DN(B,F)049					+3	—	
CAP**60**A**						+5	+3
CNP**6024A**						+3	—
CSPH*6012A**						+5	+3
FB4CNF060						+5	—
(FV4C/FE4A)NB006				+5	+5	+5	+3
FX4DN(B,F)061						+5	+3

25HBB / 25HBC / 25HCD

Table 6 – Additional Subcooling Required – 15 SEER Units

Indoor Unit	Subcooling Delta from Rating Plate Value						
	OUTDOOR UNIT TONNAGE						
	018	024	030	036	042	048	060
CAP**1814A**	---						
CNPV*1814A**	---						
FB4CNF018+TXV	---						
FF1ENP(018/019)	---						
FX4DNF019	---						
CAP**24**A**	---	---					
CNP**24**A**	---	---					
CSPH*2412A**	---	---					
FB4CNF024+TXV	---	---					
FF1ENP(024/025)	---	---					
(FV4C/FE4A)NF002	+3	---	---				
FX4DNF025	---	---					
CAP**30**A**		---	---				
CNP**30**A**		---	---				
CSPH*3012A**		---	---				
FB4CNF030+TXV		---	---				
FF1ENP030		---	---				
FF1ENP031		---	---				
FX4DN(B,F)031		+3	---				
CAP**36**A**			---	---			
CNP**36**A**			---	---			
CSPH*3612A**			---	---			
FB4CNF036+TXV			---	---			
(FV4C/FE4A)N(B,F)003		---	---	---	---		
FF1ENP036			---	---			
FF1ENP037			---	---			
FX4DN(B,F)037			+5	---			
CAP**42**A**				---	---		
CNP**4221A**				---	---		
CNPV*4217A**				---	---		
CSPH*4212A**				---	---		
FB4CNF042+TXV				---	---		
FX4DN(B,F)043				---	---		
CAP**4817A**					+5	---	
CAP**48(21,24)A**					+3	---	
CNP**48**A**					---	---	
CSPH*4812A**					---	---	
FB4CNF048+TXV					---	---	
(FV4C/FE4A)N(B,F)005			+3	+3	+3	---	---
FX4DN(B,F)049					+3	---	
CAP**60**A**						+5	---
CNP**6024A**						---	---
CSPH*6012A**						+3	---
FB4CNF060						---	---
(FV4C/FE4A)NB006				+5	+5	+3	---
FX4DN(B,F)061						+3	---

25HBB / 25HBC / 25HCD

Table 7 – Required Liquid Line Temperatures °F

LIQUID PRESSURE AT SERVICE VALVE (PSIG)	REQUIRED SUBCOOLING TEMPERATURE (° F)					
	8	10	12	14	16	18
251	76	74	72	70	68	66
259	78	76	74	72	70	68
266	80	78	76	74	72	70
274	82	80	78	76	74	72
283	84	82	80	78	76	74
291	86	84	82	80	78	76
299	88	86	84	82	80	78
308	90	88	86	84	82	80
317	92	90	88	86	84	82
326	94	92	90	88	86	84
335	96	94	92	90	88	86
345	98	96	94	92	90	88
354	100	98	96	94	92	90
364	102	100	98	96	94	92
374	104	102	100	98	96	94
384	106	104	102	100	98	96
395	108	106	104	102	100	98
406	110	108	106	104	102	100
416	112	110	108	106	104	102
427	114	112	110	108	106	104
439	116	114	112	110	108	106
450	118	116	114	112	110	108
462	120	118	116	114	112	110
474	122	120	118	116	114	112
486	124	122	120	118	116	114
499	126	124	122	120	118	116
511	128	126	124	122	120	118

Table 8 – Superheat Charging (Heat Pump Only)

OUTDOOR TEMP (° F)	EVAPORATOR ENTERING AIR TEMPERATURE (° F WB)													
	50	52	54	56	58	60	62	64	67	68	70	72	74	76
55	11	11	12	12	12	13	17	20	24	24	25	25	25	25
60	6	6	7	7	7	7	12	16	21	22	23	23	23	23
65	–	–	–	–	–	3	7	12	18	19	21	21	22	22
70	–	–	–	–	–	–	–	7	14	16	18	20	20	20
75	–	–	–	–	–	–	–	3	11	13	16	18	18	19
82	–	–	–	–	–	–	–	–	*6	8	12	15	16	17
85	–	–	–	–	–	–	–	–	4	7	11	14	15	16
90	–	–	–	–	–	–	–	–	–	4	8	12	14	15
95	–	–	–	–	–	–	–	–	–	–	6	10	12	14
100	–	–	–	–	–	–	–	–	–	–	4	8	11	12
105	–	–	–	–	–	–	–	–	–	–	3	6	9	11
110	–	–	–	–	–	–	–	–	–	–	–	5	7	10
115	–	–	–	–	–	–	–	–	–	–	–	3	6	8

*Optimum performance point, 82° F outdoor ambient and (80° F dry bulb),(67° F wet bulb) indoor conditions. (DOE B Test Conditions)
 Where a dash (–) appears do not attempt to charge system under these conditions or refrigerant slugging may occur. Charge must be weighed in.
Note: Superheat ° F is at low-side service port, Allow a tolerance of ± 3° F
Note: Indoor dry bulb between 70° F and 80° F

Table 9 – Required Suction-Line Temperature

SUPERHEAT TEMP (° F)	SUCTION PRESSURE AT SERVICE PORT (PSIG)								
	107.8	112.2	116.8	121.2	126	130.8	138.8	140.8	145.8
0	35	37	39	41	43	45	47	49	51
2	37	39	41	43	45	47	49	51	53
4	39	41	43	45	47	49	51	53	55
6	41	43	45	47	49	51	53	55	57
8	43	45	47	49	51	53	55	57	59
10	45	47	49	51	53	55	57	59	61
12	47	49	51	53	55	57	59	61	63
14	49	51	53	55	57	59	61	63	65
16	51	53	55	57	59	61	63	65	67
18	53	55	57	59	61	63	65	67	69
20	55	57	59	61	63	65	67	69	71
22	57	59	61	63	65	67	69	71	73
24	59	61	63	65	67	69	71	73	75
26	61	63	65	67	69	71	73	75	77
28	63	65	67	69	71	73	75	77	79
30	65	67	69	71	73	75	77	79	81

25HBB / 25HBC / 25HCD

FINAL CHECKS

IMPORTANT: Before leaving job, be sure to do the following:

1. Ensure that all wiring is routed away from tubing and sheet metal edges to prevent rub-through or wire pinching.
2. Ensure that all wiring and tubing is secure in unit before adding panels and covers. Securely fasten all panels and covers.
3. Tighten service valve stem caps to 1/12-turn past finger tight.
4. Leave Owner's Manual with owner. Explain system operation and periodic maintenance requirements outlined in manual.
5. Fill out Dealer Installation Checklist and place in customer file.

CARE AND MAINTENANCE

For continuing high performance and to minimize possible equipment failure, periodic maintenance must be performed on this equipment.

Frequency of maintenance may vary depending upon geographic areas, such as coastal applications. See Users Manual for information.

PURON® (R-410A) QUICK REFERENCE GUIDE

- Puron refrigerant operates at 50–70 percent higher pressures than R-22. Be sure that servicing equipment and replacement components are designed to operate with Puron
- Puron refrigerant cylinders are rose colored.
- Recovery cylinder service pressure rating must be 400 psig, DOT 4BA400 or DOT BW400.
- Puron systems should be charged with liquid refrigerant. Use a commercial type metering device in the manifold hose when charging into suction line with compressor operating
- Manifold sets should be 700 psig high side and 180 psig low side with 550 psig low-side retard.
- Use hoses with 700 psig service pressure rating.
- Leak detectors should be designed to detect HFC refrigerant.
- Puron, as with other HFCs, is only compatible with POE oils.
- Vacuum pumps will not remove moisture from oil.
- Do not use liquid-line filter driers with rated working pressures less than 600 psig.
- Do not leave Puron suction line filter driers in line longer than 72 hours.
- Do not install a suction-line filter drier in liquid line.
- POE oils absorb moisture rapidly. Do not expose oil to atmosphere.
- POE oils may cause damage to certain plastics and roofing materials.
- Wrap all filter driers and service valves with wet cloth when brazing.
- A factory approved liquid-line filter drier is required on every unit.
- Do NOT use an R-22 TXV.
- If indoor unit is equipped with an R-22 TXV or piston metering device sized for R-22 application, it must be changed to a hard shutoff Puron TXV or properly sized Puron piston metering device.
- Never open system to atmosphere while it is under a vacuum.
- When system must be opened for service, recover refrigerant, evacuate then break vacuum with dry nitrogen and replace filter driers. Evacuate to 500 microns prior to recharging.
- Do not vent Puron into the atmosphere.
- Do not use capillary tube coils.
- Observe all **warnings, cautions, and bold** text.